

---

# Doosan Lentjes

## *High efficiency biomass CFB boilers for the Asian market*

### Speaker:

Frank Leuschke  
Doosan Lentjes GmbH  
Germany

### Presented at:

POWER-GEN ASIA 2018  
18-20 September 2018  
Jakarta, Indonesia

© Doosan Lentjes GmbH



**Abstract:**

Electricity generation based on biomass incineration is about to become a substantial element of the total energy mix and plays an increasing role in the decarbonization of the energy sector. Biomass as a fuel has a variety of forms and a wide range of physical and chemical characteristics that must be addressed correctly before selecting a combustion technology.

The reduction of the CO<sub>2</sub> footprint is a critical issue for power utilities. This is why circulating fluidized bed (CFB) solutions have become the technology of choice to fulfil governments' targets on environmental performance and efforts to grow the share of renewables in the context of the energy transition. Against this background, the number of biomass projects will increase with a strong competition between developers leading to a consistent application of best available technologies (BAT) and highest efficiencies of the plants. Incentives set to steer the biomass market, such as, Feed in Tariffs (FiT) are expected to decrease in future. A CFB inherent combination of highest possible plant performance, acceptable investment cost and operational flexibility is available now.

This paper presents the design aspects of CFB boilers, co-fired with biomasses, by considering the selection of steam conditions, process design and specifics of boiler auxiliary equipment selection, as well as, the emissions control systems for those biomass co-firing applications. In this context, the experience with CFB boilers working with high steam conditions will be presented.

**Introduction:**

The decision to reduce greenhouse gas emissions, especially CO<sub>2</sub> –confirmed in Paris- resulted in a slowdown of fossil fuel utilization for power production. Consequently financial institutes get more and more reluctant to financing coal fired power plants. This changes boundary conditions for new fossil fuel power plants drastically; besides cycling of the operation, higher flexibility towards variation of fuels is more and more required. More specifically, incineration or at least co-incineration of biomass is to be taken into consideration from now on. In addition and based on local availability opportunity fuels such as waste, petroleum byproducts, agricultural

and others may be considered by investors. Modern CFB technology is the right technology solution for the power plants in transition of power sector we observe.

### The CFB Technology:

Since 1976, when the CFBC base patent was granted to the German company Lurgi, the CFB principle placed the fluidization velocity in a regime between the classical fluid bed (bubbling bed) and the transport reactor,

where the so-called slip velocity - the difference between the mean gas velocity and the mean solids velocity - is at its largest. There high internal solids recirculation occurs, allowing the optimum mixing of gas and solids and

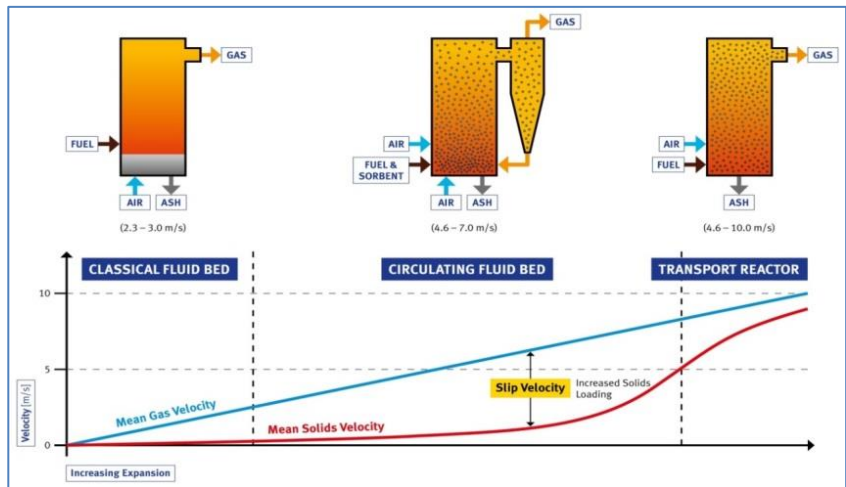

achieving the best performance in terms of heat and mass transfer as well as high temperature uniformity, while burning a wide range of fuels.

Via high efficient cyclones the entrained solid particles are returned to the bed and the combustion process provides superior residence time for the combustion of various types of solid fuels.

In opposite to Pulverized Coal (PC) type boilers the CFB technology is characterized by uniform heat transfer combined with relatively low combustion temperature typically kept in range of 850 - 950 Celsius. The CFB boiler technology provides not only high combustion efficiency but due to controlled low combustion temperature also inherently low emissions of nitrogen oxides. Sulfur dioxide emission can be effectively controlled by simple addition of limestone into combustion chamber. Depending on the type of the fuel sulfur retention can be even higher than 99% without necessity of installation of external FGD plants.

## Doosan Lentjes CFB Process

Fuel combustion in a Circulating Fluidized Bed system takes place in a vertical chamber referred to as the Combustor, in which the fluidization of the fuel and the fuel combustion take place. The fuel is fed into the combustor and is burnt at approx. 870 °C.

The bed material is fluidized by preheated primary air introduced through a nozzle grate at the bottom of the combustor, by preheated secondary air added at two levels and by the combustion gases generated which flow upwards at a relatively high fluidizing velocity. Thus, the entire combustor contains a high concentration of suspended solids which decrease continuously towards the top of the combustor. The flue gas entrains a considerable portion of the solids inventory from the combustor. The bulk of these entrained solids is separated from the gas in the separators and is continuously returned to the bed by the recycle loops.

The very high internal and external circulating rates of solids, characteristic of the Circulating Fluidized Bed, result in consistently uniform temperatures throughout the combustor and the solids recycle system – a typical feature of Doosan Lentjes CFB's.

Because of the high slip velocity between gas and solids, the solids proceed through the combustor at a much lower velocity than the gas. Generally, average solids residence times in the order of minutes are obtained for each cycle of solids circulation.

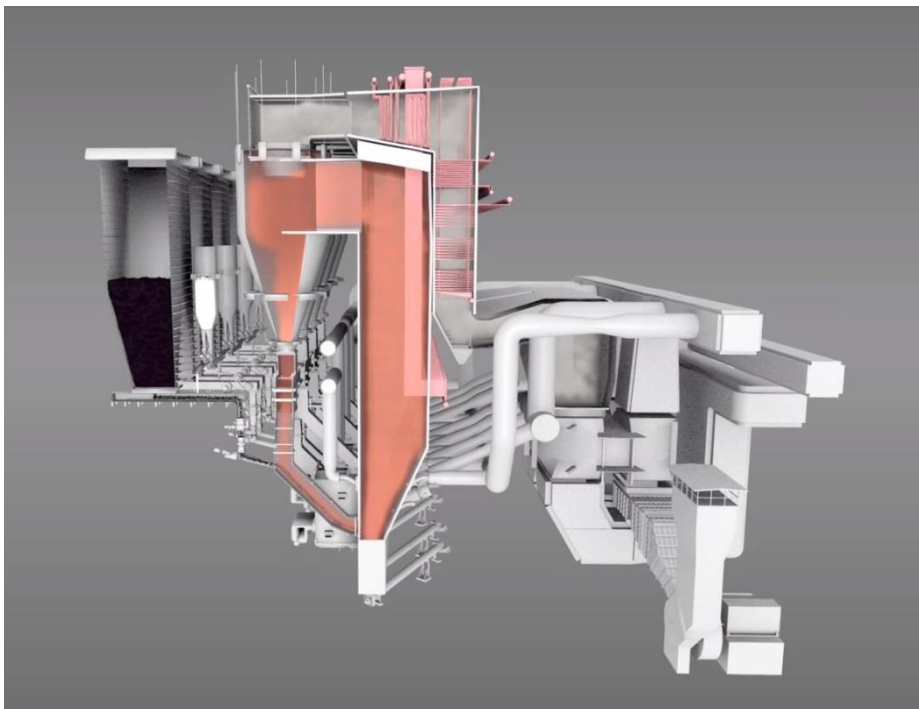

The long residence and contact times, coupled with the small particle sizes and efficient heat and mass transfer rates, lead to high combustion efficiency for a wide range of solid fuels. The relatively high ratio of solids circulation to

fuel feed amount means that the combustor inventory consists mainly of recycled solids while the actual carbon content is surprisingly low. Furthermore, the large thermal inertia of the recycled solids allows the CFB system easy handling of fuels with wide range of ash, moisture, heating value and sulphur content (limestone may be fed to the furnace for direct desulphurization) than conventional combustion systems. Consequently, the combustion of low and high grade fuels, as well as combination of such fuels in a CFB system has been proven to be very stable and efficient.

Combustion air is introduced into the combustor at multiple levels. About half of the combustion air is passed as primary fluidizing air through the grate at the bottom. The balance is admitted as preheated secondary air through multiple ports in the side walls. Combustion therefore occurs in two zones: a primary reducing zone in the lower section of the combustor, and complete combustion using excess air via the secondary air ports in the upper section. This “Staged Combustion”, at controlled low temperatures effectively suppresses thermal NO<sub>x</sub> formation.

The produced flue gas along with the entrained solids exit the combustor via symmetrical gas outlets located in the upper portion of the water wall and is then routed to the recycling cyclones (solid separators) designed to remove more than 99 % of the solids entrained by the gas from the combustion chamber.

The cleaned flue gas exiting the separators enters the back pass, which similar to a conventional boiler back pass consists of:

- multiple sections of superheat surfaces
- water/steam cooled enclosure
- multiple sections for economizer surface
- Downstream the boiler back pass air heater for both primary and secondary air is installed.

Heat for steam generation is removed from the system in three main areas:

- A **primary loop**, where heat is removed from the solids circulating in the CFB system. Here the heat removal is achieved by transfer through the water walls of the upper non-refractory lined part of the combustor. This surface is typically used for evaporation.
- The **fluidized bed heat exchangers** (FBHE), each consisting of a fluidized bundle chamber. Part of the hot solids (about 850°C), collected in the solid separators, are controlled and directed into the FBHE via the so called spieß valves. The FBHE, containing super-heater and/or re-heater surfaces, is fluidized in order to maintain flow and optimum heat transfer conditions. The cooled ash is then reintroduced into the combustor. The system basically operates like a conventional stationary Fluidized bed.
- A **back pass** where further heat is removed from the flue gas to superheater, reheater and economizer surfaces followed by the standard combustion air preheater.

The solids separated by the recycling separators are collected and returned directly into the combustor via seal pots, fluidized with a small amount of air. The solids returning via this route to the combustor are still at the combustor temperature.

Part of the solids from the seal pots are directed at a controlled rate to the FBHE's for heat removal and subsequently returned to the combustor at lower temperature. Bed makeup material, such as sand can be fed directly into the combustor. Normally, sand/bottom ash addition is necessary during first start-up or a restart after having emptied the plant and at operation conditions firing fuels not providing sufficient ash to stabilize the required bed height.

The bottom ash discharged from the combustor needs cooling in ash coolers, whereas the fly ash is routed through the dust collector where it is discharged without further cooling.

An oil system including a set of over-bed burners for start-up of the combustion system is used to bring the CFB combustion system up to solids fuel ignition temperature during start-up procedure.

## Aspects of Biomass Combustion in Coal Fired CFB Boilers

Since more than 40 years the CFB technology has proven to be the perfect technology for combustion of all kind of solid fuels.

The diagram shows various fuels described by their heating value and content of ash and moisture, which have been burnt in CFB successfully.

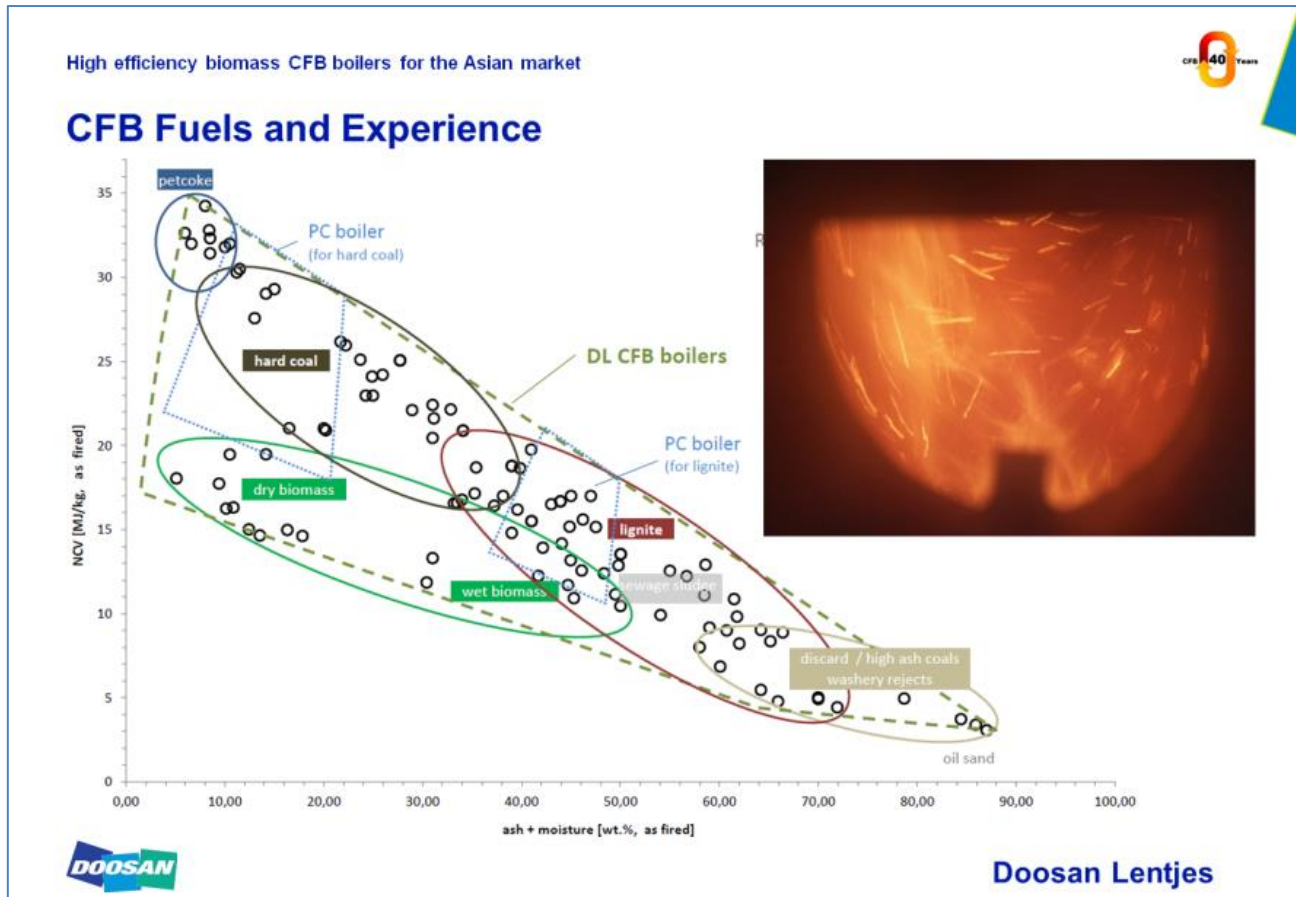

Since beginning of the industrialization, the CO<sub>2</sub> concentration in atmosphere is increasing drastically and global warming and its severe effects is more and more becoming reality. Burning fossil fuels has been found to be the main contributor. In difference to all fossil fuels which stored carbon for millions of years under ground the combustion of biomasses does not contribute to CO<sub>2</sub> addition to the atmosphere, just due to the fact that only carbon is converted, which has recently been taken out of the atmosphere and which at the same time will be again absorbed by currently growing plants.

## Solid Fuels

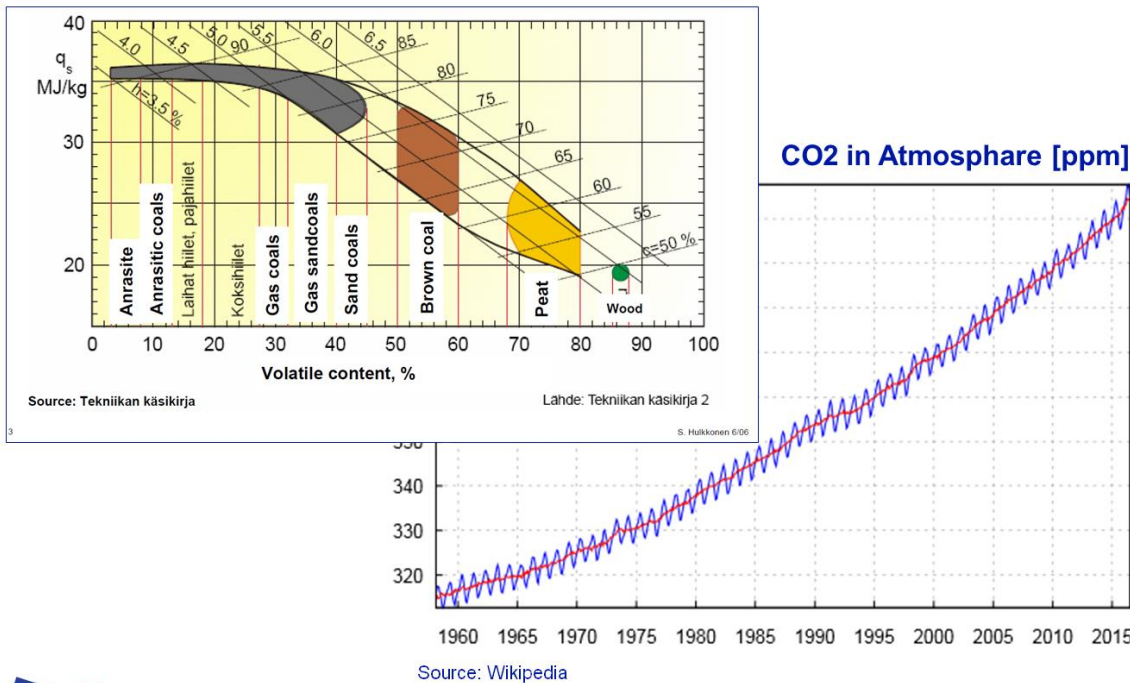

Doosan Lentjes

In recent years, CFB boiler plant owners try to improve plant economy by utilizing opportunity fuels that can be co-fired with main fuel. The opportunity fuels often include various byproducts, wastes, as well as biomass. Biomass becomes very attractive fuel due to the fact that many countries try to achieve ambitious targets regarding reduction of CO<sub>2</sub> emission. Nevertheless Government subsidy schemes and other financial instruments offered for power producers are different and depend on the country energy policy. The focus of the market is basically on the new built dedicated biomass plants (due to often higher incentives) but also owners of existing coal fired plants checking the possibility of participation in this sector of the energy market. It must be underlined that co-combustion of biomass is relatively low cost approach allowing substantial increase of renewable energy production by the industry and utilities.

Various converted Doosan Lentjes CFB boilers in Europe originally designed for coal combustion already proved their fuel flexibility, co-firing up to 40 % LHV base without compromise on boiler performance and plant reliability.



Also full conversion from coal to biomass has been successfully executed. Doosan Lentjes delivered cutting-edge CFB technology and flue gas cleaning (FGC) technology at the Provence CFB Power Station in Gardanne, France. Doosan Lentjes work formed part of a comprehensive coal-to-biomass conversion. This approach contributes to owner commitment to clean, high-performance energy production, and is expected to reduce their CO<sub>2</sub> balance by 600.000 tons per year.

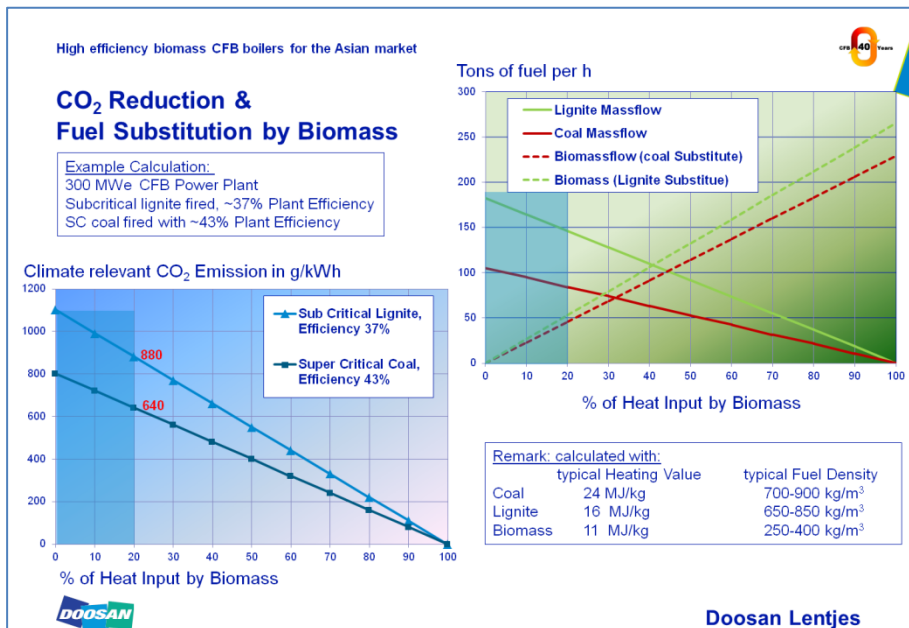

It is worse to note that co-combustion of about 20% of biomass in a 300 MWe CFB provides the same or even more CO<sub>2</sub> reduction as a single 60 MWe biomass plant, while combining the basic advantages of the utility size boiler e.g. utilizing high steam parameters and highly efficient steam

cycles and turbines. Furthermore, due to typically low ash and sulfur content of biomasses, cost for required sorbent and ash disposal is reduced, while typical disadvantages of 100% biomass firing only are mitigated by the typical coal constituents:

- Risk of high temperature corrosion due to higher Cl content of biomass (mitigated by higher S content of coal providing a sufficient S/Cl ratio)
- Risk of fouling due to typical high alkaline content of biomass (mitigated by higher ash content of coal and related dilution of alkaline content)

## Design considerations and Challenges for Biomass Combustion

Even though the CFB technology in difference to PC technology can handle all different kind of solid fuels it is important to know that this very wide range of different solid fuels does require specific design considerations and does provide specific design challenges.



Especially biomasses available on the market vary in a very wide range which makes it specifically important to thoroughly consider the following:

- The biomass depending on its origin is a challenging fuel typically containing alkalis such as sodium and potassium that are increasing the risk of fouling and slagging. Taking into consideration presence of chlorine additional risk of high temperature corrosion may occur.

- Additional fuel storage and feeding system and preparation plant shall be foreseen in design phase to avoid unnecessary cost escalation. Fuel transportation cost can be decreased by decentralized pretreatment.
- Biomass quality varies with seasons and sources.

High efficiency biomass CFB boilers for the Asian market

**Initial Biomass Experience in CFB**

**5 Units in California / USA**

- Rocklin
- Fresno
- Mecca I + II
- Lone (after conversion)

1988 / 89 / 92 & 2010

**Steam Parameters**

Pressure 80 – 90 bar  
 Temperature 480 – 510 ° C  
 Efficiency 29 – 31 %



Doosan Lentjes

High efficiency biomass CFB boilers for the Asian market

**Wood Waste Combustion (Rio Bravo, Fresno, Rocklin / Ca, US)**



Doosan Lentjes

Pic. 7 & 8, initial CFB Biomass Experience

First CFB boilers for 100% biomass combustion have already been built in the 80-ties of last century. In order to avoid described risks related to varying biomass sources the live steam parameters used have been selected very conservative (about 80-90 bar, 480-510°C), resulting in comparatively low plant efficiencies.

High efficiency biomass CFB boilers for the Asian market

**Example Biomass : typical Properties**

Fuels	C	H2	S	O2	N2	Ash	Cl	Na	K
	%-daf	%-daf	%-daf	%-daf	%-daf	%-dry	%-daf	mg/kg-d	mg/kg-d
Peat	55	5,5	0,2	33	1,7	5			
Wood, coniferous	51	6,3	0,02	42	0,1	0,3	0,01	20	400
Wood, deciduous	49	6,2	0,02	44	0,1	0,3	0,01	50	800
Bark, coniferous	54	6,1	0,1	40	0,5	4	0,02	300	2 000
Bark, deciduous	55	6,1	0,1	40	0,3	5	0,02	100	2 000
Willow	49	6,2	0,05	44	0,5	2	0,03	200	3 000
Poplar	49	6,3	0,03	44	0,4	2	0,01		3 000
Straw, wheat, rye, barley	49	6,3	0,1	43	0,5	5	0,4	500	10 000
Straw, rape	50	6,3	0,3	43	0,8	5	0,5	500	10 000
Reed canary grass, summer harv.	49	6,1	0,2	43	1,4	6,4	0,6	200	12 000
Reed canary grass, delayed harv.	49	5,8	0,1	44	0,9	5,6	0,1	200	2 700

**Most Critical Biomass Elements:**

Chlorine: high temp. Corrosion / Fouling / HCl emission / Dioxines  
 Alkaline Metals: Fouling, Slagging / Bed Sintering / Corrosion  
 Heavy Metals: Corrosion, Emissions / Ash Treatment  
 Nitrogen: NO<sub>x</sub> Emission

Doosan Lentjes

Boiler designers can mitigate technical risk with special design consideration including proper steam parameters selection, pressure part materials, flue gas temperature profiles etc.

High efficiency biomass CFB boilers for the Asian market

**Modern Biomass CFB: Strongoli**

Year of Commissioning 2003

- Total Electrical Output 50 MWe
- Technical Boiler Data (per 1 Boiler)
  - Number of Boilers 2
  - Live Steam 79 t/h
  - 515 °C
  - 95 bar
  - Feedwater 160 °C
  - Biomass Flow 21 t/h
  - Flue Gas 94.000 m<sup>3</sup>/h (STP)
  - Thermal Capacity 60 MWth



Doosan Lentjes

High efficiency biomass CFB boilers for the Asian market

**Design Fuel Data**

Imported wood chips

	Local stem wood / branches	
■ L H V (a.r.)	8,0	13,3 MJ/kg
■ Ash	3,0	8,0 wt.-%
■ Moisture	25,0	50,0 wt.-%
■ Sulphur	0,00	0,05 wt.-%
■ Chlorine	0,01	0,1 wt.-%
■ Alkali	0,0	0,5 wt.-%



Doosan Lentjes

High efficiency biomass CFB boilers for the Asian market

**Strongoli Guarantee Data**

Emissions (based on 11 % O<sub>2</sub>,dry)

- SO<sub>2</sub> 50 mg/m<sup>3</sup> (STP)
- NO<sub>x</sub> 200 mg/m<sup>3</sup> (STP)
- CO 50 mg/m<sup>3</sup> (STP)
- TOC 10 mg/m<sup>3</sup> (STP)
- Dust 10 mg/m<sup>3</sup> (STP)
- HCl 10 mg/m<sup>3</sup> (STP)
- Flue-Gas Stack Temperature 130 °C

Thermal Efficiency (DIN 1942) 91,7 %



Doosan Lentjes

Pic. 10,11, 12

Pictures 10-12 show the Strongoli CFB biomass site in the south of Italy and its relevant technical data. The plant has been commissioned in 2003. The boiler plant consists of 2 CFB boilers with a modern design, providing a modern CFB boiler concept which consists of an integrated FBHE and a cooled cyclone arrangement. The plant

runs successfully on various imported wooden biomass sources, in recent years mainly different wood chips. Efficiency, as well as all guaranteed emission limits have been met easily.

### Advanced Fluidized Bed Heat Exchangers

The Fluidized bed heat exchangers allow controlling the combustion temperature at an optimum level over a wide load range. An advanced FBHE design is made of water cooled panels integrated within the lower furnace as part of the evaporator system. Due to water cooled design, temperature differences are minimized and thermal expansion mitigations, such as expensive and

unreliable expansion joints can be avoided. FBHEs allow precise control of combustion process (temperature) in case of variations in fuel heating value or its combustion properties.

Heat extraction from the recirculated ash is advantageous with regard to optimized heat transfer. Therefore typically the hottest surfaces (final superheater and re-heater) are located in the FBHE. In case of biomass combustion to submerge these surfaces in the FBHE is even more advantageous due to the fact that most of the Cl content is released as HCl within the flue gas and leaves the combustor via the vortex finder and therefore cannot get into contact with these most critical surfaces for high temperature chlorine corrosion.

### **Co-firing of Biomass in CFB boilers**

Due to the superior fuel flexibility CFB boilers have already proven in the past, co-firing of biomass with coal appears to be one very effective way to mitigate major technical risks with the biomass combustion. Simultaneously it might increase at the same time the social acceptance and will provide additional commercial chances, summarized as follows:

- SO<sub>2</sub> originated for coal sulfur content can convert gaseous alkali chlorides to alkali sulfates.
- Coal ash minerals like alumina inosilicates are capable to bond alkalis introduced with biomass to combustion process
- Cost for ash disposal and sorbent for SO<sub>2</sub> capture is reduced
- Social acceptance of the power plants burning biomass is much higher
- Chances to get financing of biomass projects is much better
- Possibility to get incentives for burning biomass (depending on local regulations)

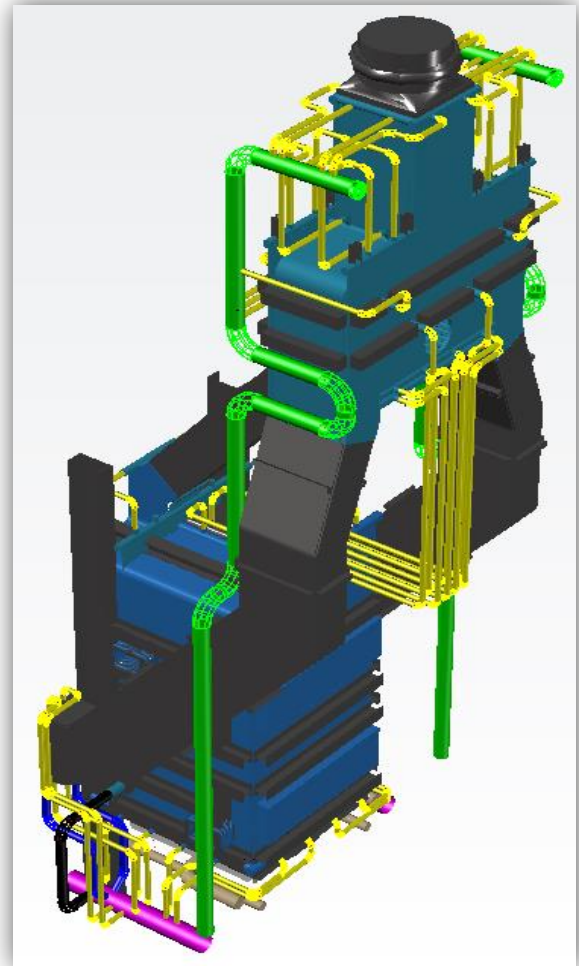

## Berlin CFB, Example for retrofit of exiting CFB to Biomass Co-firing



As a good example for a successful retrofit from coal fired CFB system to a co-combustion plant, the German Berlin CFB installation is highlighted in the following. The plant was required to supply both, supplying heat for the existing city district heating system as well as power to be fed to the electrical grid. The plant is located in the middle of the city.

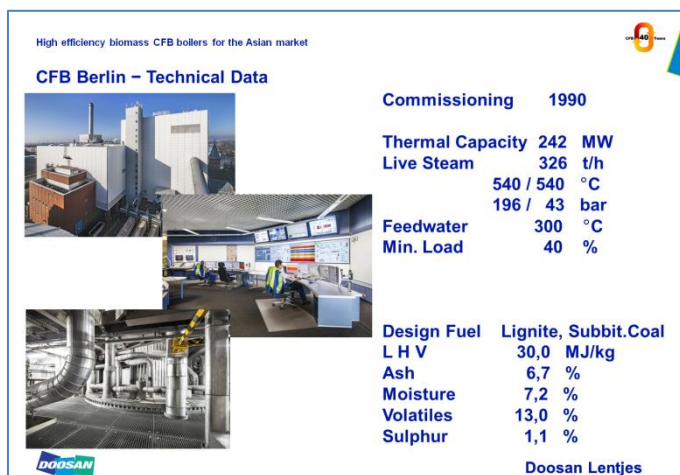

The design works for this unit started when West Berlin was still an island within the former eastern bloc and nobody was expecting this to change soon. Therefore, specific design considerations were requested to reach highest possible availability, rapid capacity ramping and high efficiency to serve the specific needs of the cities island situation. The plant was designed for German hard coal, supplied to the city site by train.

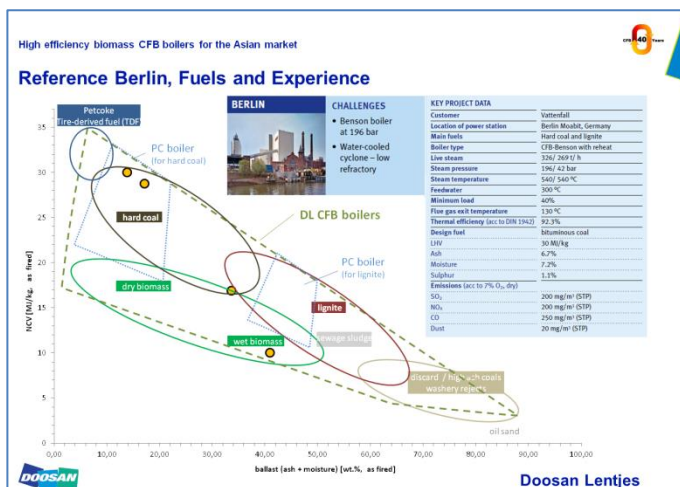

Consequently, the 100 MWe Berlin plant was the world's first CFB equipped with two water cooled cyclones to minimize the amount of refractory installed and thus providing faster load response.

Furthermore, the boiler was designed with the once-through concept (Benson type boiler) and a steam-reheat system (540°C; 196/43 bar) to provide highest possible efficiency. In fact, in CHP mode, the Berlin CFB still demonstrates fuel utilization ratio of > 75%.

Soon after commissioning unexpectedly the political situation changed drastically. German became re-unified and West-Berlin was no longer an island. In relation to this the fuel sourcing possibilities changed and the commercially more interesting operation on various coals, including Polish, Columbian and other imported coals became a reality. Also the East German lignite became available now for economic combustion. The plant with its CFB technology inherent fuel flexibility has proven successfully to operate with all those fuels.

With beginning of the new century, Berlin had become the capital of reunified Germany, in the meantime environmental discussions in the city increased. Even though the plant was still in the position to comply with all relevant emissions regulations, for some time a closure of the CFB plant was on the political agenda. In order to cope with the local environmental and social situation first very successful tests with biomass addition were undertaken. As a result, the plant was equipped with addition storage and feeding equipment to operate on about 25% (by heat input) of local waste wood biomass. Soon after making use of an unused old turbine hall a further increase to today's capacity of 40% biomass became reality. Only due to that achievement and the related high acceptance of the local society the plant finally received the official permission to extend its operation at least till 2030. Currently, the client is investigation a further increase of the biomass capacity for full conversion to an only biomass operation.

### **High efficient modern CFB for Biomass combustion for Asia**

For some time we see a rising demand for efficient biomass combustion also on the Asian market and it is no longer only a European topic. This is even more important, since many Asian countries still have an increasing demand for power which shall be served in a more and more in a low CO<sub>2</sub> producing manner. Furthermore, in Asia there is abundant biomass available

Based on our long history and experience in CFB boilers and biomass combustion Doosan Lentjes can offer two different technical solutions, to serve the different commercial, economic, social and political situations in these countries:

- Co-combustion of a certain amount of biomass in high efficient (SC or USC) utility size CFB boilers (for 300 MWe and above)
- State of the Art high efficient CFB boilers for biomass combustion (with a typical range of 50-100 MWe)

As an example for a state of the art high efficient CFB boiler the following modular concept may serve, which is based on currently ongoing projects. The picture shows the full process chain. The heart of the plant is the full membrane wall type combustion chamber, with all membrane type integrated backpass, cooled cyclone return pipes and FBHE.

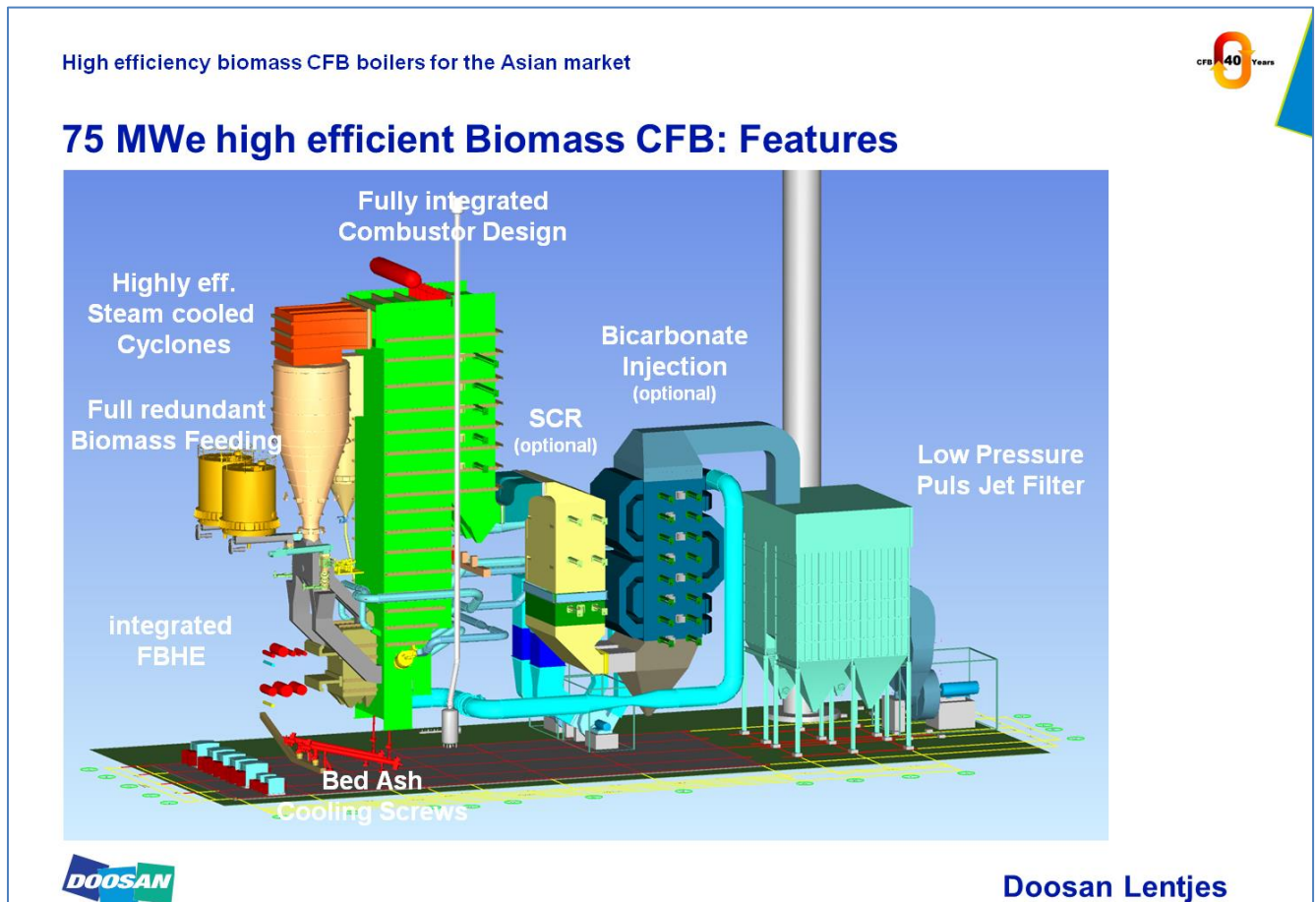



This CFB concept itself proved to sufficiently fulfil typical requirements on gaseous emissions without additional flue gas cleaning equipment (except bag house or ESP). Nevertheless, just in case due to specific local regulation very low emission limits are set up, the plant layout can be easily added by optional SNCR or SCR and lime or sodium bicarbonate powder injection to further reduce the low raw gas emissions of the biomass CFB combustion to figures of below 50

CFB 40 Years

High efficiency biomass CFB boilers for the Asian market

### High efficient 75 MWe Biomass CFB: technical Data

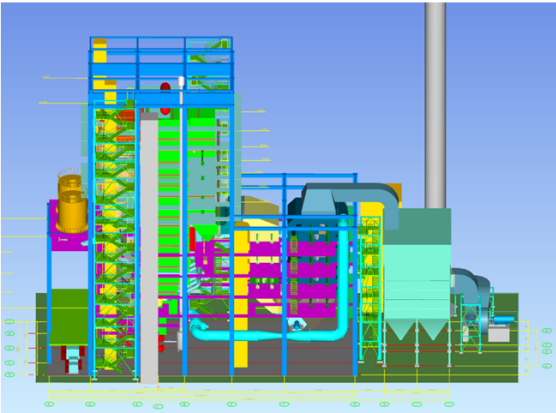
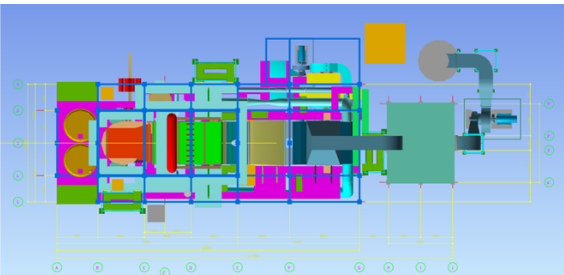
- Power Capacity<sub>gross</sub> 75 MWe
- Live / Reheat Steam 224 / 204 t/h  
563 / 562 ° C  
170 / 40 bar
- Feedwater Temperature 263 ° C
- Biomasses: wood pellets & PKS

		min.	max.
L H V	(MJ/kg)	16,1	18,1
Ash	(%)	0,5	1,8
Moisture	(%)	4,6	9,1
Sulphur	(%)	0,0	0,1
Chlorine	(%)	0,01	0,05
- Emission limits
  - SO<sub>2</sub>: 50 - 150 mg/Nm<sup>3</sup>
  - NO<sub>x</sub>: 50 - 200 mg/Nm<sup>3</sup>
  - Dust: 20 - 50 mg/Nm<sup>3</sup>
- Boiler Efficiency (LHV) > 94 %
- Plant Efficiency<sub>gross</sub> > 42 %

Doosan Lentjes

mg/Nm<sup>3</sup>.

Assuming that the biomass source for such plant is within an acceptable range with specific regard to its Cl content the plant may be equipped with a reheat facility (within the integrated FBHE) and may use steam parameters up to 565°C and 170bar. With this plant configuration a boiler efficiency of 94%, respectively a plant efficiency of about 42% can be guaranteed.

When it comes to larger capacity the combustion chamber and backpass size would be increased accordingly to still provide the required flue gas velocity for best fluidization and mixture, while the number of cyclones and feed points will double.

## 75 MWe CFB for Biomass: Longitudinal Cut

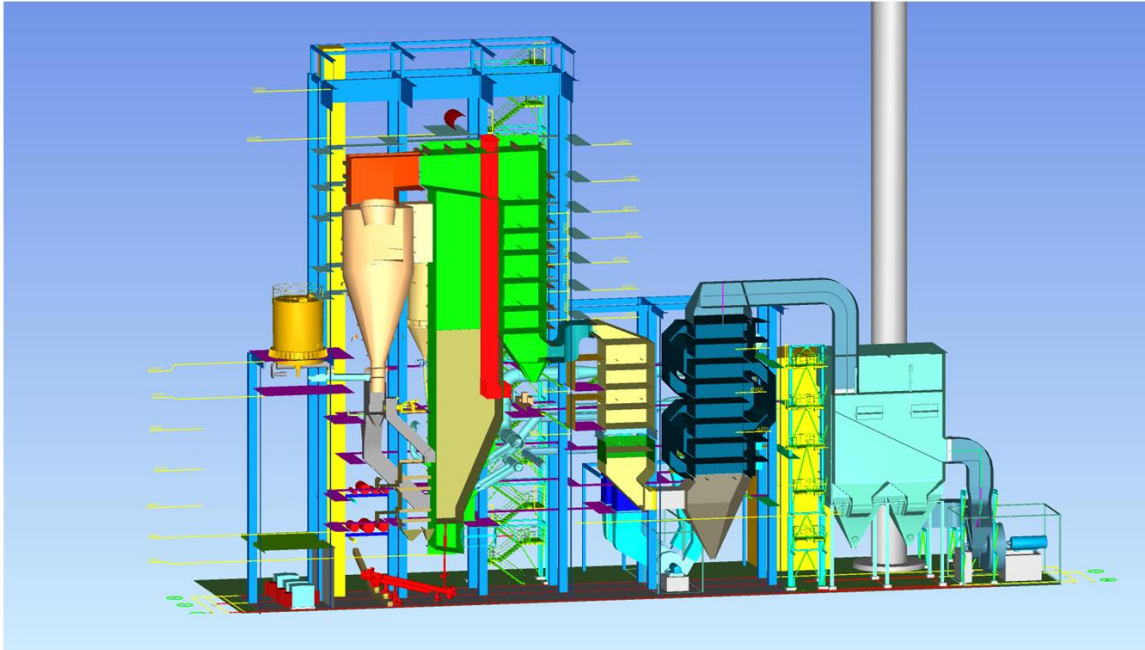

Doosan Lentjes

### Summary

CFB plant capacity can range from small industrial boilers up to utility scale with super and ultra-super critical steam parameters. Numerous large size Doosan Lentjes CFB power plants are in operation currently. Most of the large Doosan Lentjes CFB boilers plants are equipped with reheat system.

Within the more than 100 CFB power plants designed by the Doosan Lentjes forerunner company Lentjes, all the advanced water/steam systems such as natural circulation, once through forced-flow and forced circulation with live steam pressures close to 200 bar and superheat temperatures up to 565 °C have already been applied. As CFB technology is matured, large size CFB utility plants are being developed. Fuel flexibility, the ability to burn waste fuels, environmental suitability and proven commercial viability has been the main factors for this

development. Future potential of mono or co-incineration of biomass is an advantage in global power sector transition will be witnessed in next decades.

**References:**

1. *40 Years of Circulating Fluidized Bed (CFB) Power Plant Technology- Damian Goral, Reinhard Knittel, Silvio Löderbusch, Dr. Hans Piechura and Dr. Ludolf Plass*
2. *VGB Power Tech 2008 – Advantages and Limitations of Biomass-Co-combustion in Fossil Fired Power Plants*
3. *Doosan Lentjes marketing materials – [www.doosanlentjes.com](http://www.doosanlentjes.com)*